

# Part Number: SMR62

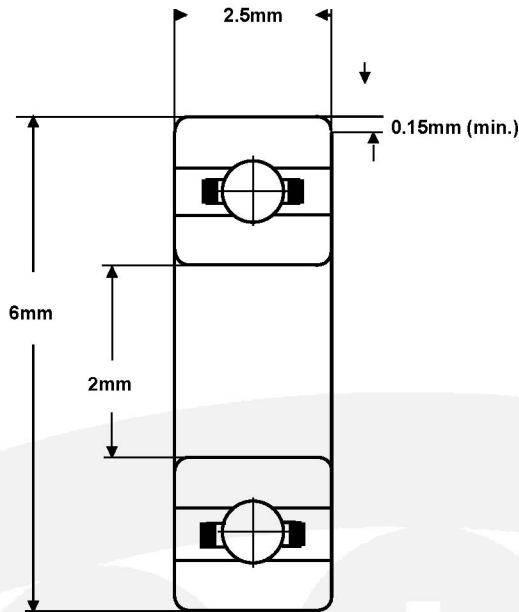

<b>Material (rings &amp; balls)</b>	KS440 / AISI-440C stainless steel
<b>Material (cage)</b>	AISI-304 stainless steel
<b>Closures</b>	None
<b>Load rating (stat)</b>	8 Kgf
<b>Load rating (dyn)</b>	27 Kgf
<b>Speed Limit *</b>	90,000 rpm
<b>Standard Lubrication **</b>	Aeroshell Fluid 12 oil

\* with adequate lubrication

\*\* may vary

**These bearings comply with EU ROHS and REACH regulations.**

RADIAL PLAY	MC1	MC2	MC3	MC4	MC5	MC6
(microns)	0 - 5	3 - 8	5 - 10	8 - 13	13 - 20	20 - 28

TOLERANCE	P0	P6	P5
<b>Bore Deviation</b>	+0 / -0.008mm	+0 / -0.007mm	+0 / -0.005mm
<b>OD Deviation</b>	+0 / -0.008mm	+0 / -0.007mm	+0 / -0.005mm
<b>Width Deviation</b>	+0 / -0.040mm	+0 / -0.040mm	+0 / -0.040mm
<b>Bore Variation</b>	10	9	5
<b>OD Variation</b>	10	9	5
<b>Width Variation</b>	12	12	5
<b>Inner Radial Runout</b>	10	5	4
<b>Outer Radial Runout</b>	15	8	5